



# Instruction manual



2025-02-19

## Fry-top griddle plate smooth chromed FTHC 708 G

[www.rmgastro.com](http://www.rmgastro.com)



# OBSAH

<b>1. DECLARATION OF CONFORMITY</b>	<b>3</b>
<b>2. TECHNICAL DATA</b>	<b>3</b>
<b>3. TABLE OF GASES FOR WHICH THE PRODUCT IS INTENDED</b>	<b>3</b>
<b>4. LOCATION ELECTRIC</b>	<b>4</b>
<b>5. LOCATION GAS</b>	<b>4</b>
<b>6. SAFETY MEASURES FOR FIRE PROTECTION</b>	<b>4</b>
<b>7. INSTALLATION</b>	<b>5</b>
<b>8. THERMAL OUTPUT CHECK</b>	<b>5</b>
<b>9. CONNECTING GAS CONNECTION HOSE</b>	<b>5</b>
<b>10. LIQUID GAS CONNECTION</b>	<b>5</b>
<b>11. WATER CONNECTION</b>	<b>6</b>
<b>12. CONNECTING THE ELECTRICAL CABLE TO THE NETWORK</b>	<b>6</b>
<b>13. CHECK DEVICE SETTINGS FOR GAS TYPE</b>	<b>6</b>
<b>14. TABULKA TRYSEK</b>	<b>7</b>
<b>15. KONTROLA NASTAVENÍ PŘÍSTROJE NA DRUH PLYNU</b>	<b>7</b>
<b>16. NÁVOD K POUŽITÍ</b>	<b>10</b>
<b>17. CLEANING AND MAINTENANCE</b>	<b>10</b>

## 1. DECLARATION OF CONFORMITY

Decree of the Ministry of Health of the Czech Republic no. 38/2001 Coll. of 19 January 2001 Regulation (EC) No 1907/2006 - Registration, Evaluation, Authorisation and Restriction of Chemicals (REACH) Regulation of the European Parliament and Council Regulation (EC) no. 1935/2004 of 27 October 2004

The products meet the requirements of §26 of Act No.258/2000 as amended. The products meet the requirements of RoHS Directive 2015/863/EU, 10/2011, 517/2014, 2015/1094, 2015/1095.

Attention, the manufacturer gives up any responsibility in case of direct and indirect damage that is related to poor installation, incorrect intervention or adjustments, insufficient maintenance, incorrect use and which are eventually caused by other causes than the points referred to in the conditions of sale. This appliance is intended only for professional use and must be operated by qualified persons. Parts that have been secured by the manufacturer or authorized worker after the setting rebuild.

## 2. TECHNICAL DATA

The label with technical data is located on the side or back panel of the device. Please read the wiring diagram and all the following information in the attached manual before installation.

Net Width [mm]	Net Depth [mm]	Net Height [mm]	Net Weight [kg]	Power gas [kW]	Griddle dimensions [mm x mm]
800	730	300	75.00	14.000	560 x 770

**The maximum and reduced nominal heat input in kW is related to the Hi of the gas used. If the product is connected to LPG, the gas cylinder must be in sufficiently ventilated rooms.**

## 3. TABLE OF GASES FOR WHICH THE PRODUCT IS INTENDED

Execution	Product Category	Connection overpressures (mbar)	Used gas	Country of destination
A1	I2E	20	G20	DE, NL, PL, RO
A1	I2ELL	20, 20	G20,G25	DE
A1	I2E+	20/25	G20/G25	BE, FR
A1	I2H	20	G20	AT, BG, CH, CZ, DK, HR, EE, ES, FI, GB, GR, IE, IT, LT, LV, NO, PT, RO, SE, SI, SK, TR, LU, CY, FR
A1	I3B/P	30	G30	BG, CY, CZ, DK, GB, HR, EE, FI, FR, GR, HU, IT, LT, LV, MT, NL, NO, RO, SE, SI, SK, TR
A1	I3B/P	50	G30	AT, DE, CZ, CH, FR, SK
A1	I3P	37	G31	BE, CH, CZ, ES, GB, GR, IE, RO, SI, SK, FR, NL, PT, HR, IT, LT, PL, TR
A1	I3+	28-30/37	G30/G31	BE, CH, CY, CZ, EE, ES, FR, GB, GR, IE, IT, LT, PT, SI, SK, TR
A1	II2E3B/P	20, 50	G20, G30	DE, PL, RO
A1	II2ELL3B/P	20, 20, 50	G20, G25, G30	DE
A1	II2E+3+	20/25, 28-30/37	G20/G25, G30/G31	BE, FR
A1	II2H3B/P	20, 30	G20, G30	BG, CZ, GB, DK, HR, EE, FI, GR, IT, LT, LV, NO, RO, SE, SI, SK, TR, CY, FR
A1	II2H3B/P	20, 50	G20, G30	AT, CH, CZ, FR, SK

Execution	Product Category	Connection overpressures (mbar)	Used gas	Country of destination
A1	I12H3P	20, 37	G20, G31	CH, CZ, ES, GB, GR, IE, RO, SI, SK
A1	I12H3+	20, 28-30/37	G20, G30/G31	CH, CY, CZ, EE, ES, GB, GR, IE, IT, LT, PT, SK, SI, TR

#### 4. LOCATION ELECTRIC

For the correct operation and placement of the appliance, it is necessary to observe the following all prescribed standards for the given market. Unpack the device and check that the device has not been damaged during transport. Place the device on a horizontal surface (maximum unevenness up to 2°). Small unevenness can be leveled with adjustable feet. If the device will be placed in such a way that it will be in contact with the walls of the furniture, these must withstand a temperature of up to 60°C. Installation, adjustment, commissioning must be performed by a qualified person who is authorized to perform such operations, according to applicable standards. The device can be installed separately or in series with devices of our production. A minimum distance of 10 cm from flammable materials must be observed. In this case, it is necessary to secure the appropriate modifications to ensure the thermal insulation of the combustible parts. The appliance must only be installed on a non-flammable surface or against a non-flammable wall. **Parts of the appliance provided by the manufacturer. or his representative, the worker performing the installation may not rebuild the product.**

#### 5. LOCATION GAS

For the correct activity and location of the appliance, it is necessary to observe all directives and standards of the country. Expand the device and check that the device has not been damaged during transport. Place the device on the horizontal surface (maximum inequality up to 2 °). Minor inequalities can be balanced with regulated legs. If the device is located in contact with the walls of the furniture, they must withstand temperatures up to 60 ° C. Installation, adjustment, commissioning must be carried out by a qualified person who is authorized for such acts, according to valid standards. The device can be installed separately or in a series with our production devices. It is necessary to follow a minimum distance of 10 cm from flammable materials. In this case, it is necessary to ensure the appropriate adjustments to ensure the thermal insulation of flammable parts. The appliance must only be installed on a non -flammable surface or at a non -flammable wall. **The smallest required air flow from the outdoor space for appliances in design and in the range of 5-20 m3/h, depending on the type of appliance. It depends on the installation regulations for the country of destination. Components of the appliance secured by the manufacturer. Or his representative must not rebuild the worker's installation of the product. The device must be installed in a suitably ventilated environment.**

#### 6. SAFETY MEASURES FOR FIRE PROTECTION

- the appliance may only be operated by adults
- the appliance may be used safely in accordance with applicable market standards:

Fire protection in spaces with special risk or danger

Protection against the effects of heat

- the appliance must be placed so that it stands or hangs firmly on a non-combustible surface

Objects of flammable substances must not be placed on the appliance at a distance less than a safe distance from it (the smallest distance between the appliance and flammable substances is 10 cm).

Table: degree of flammability of building materials included in st. flammability of substances and products

Degree of flammability	Building materials
A - non-flammable	granite, sandstone, concrete, brick, ceramic tiles, plaster
B - Not easily flammable	Acumin, Heraclitus, Lihnos, Itaver

Degree of flammability	Building materials
C1 - highly flammable	wood, hardwood, plywood, hard paper, umakart
C2 - moderately flammable	chipboards, solodur, cork boards, rubber, flooring
C3 - Highly flammable	wood fiber boards, polystyrene, polyurethane, PVC

- information on the degree of flammability of common building materials is given in the table above. Appliances must be installed in a safe manner. During installation, the relevant design, safety and hygiene regulations must also be respected:
- fire safety of local appliances and heat sources
- fire protection in areas with special risk or danger
- protection against the effects of heat

## 7. INSTALLATION

**Important:** The manufacturer does not provide any warranty for defects arising as a result of incorrect use, failure to follow the instructions contained in the attached user manual and mishandling of appliances. Installation, modification and repair of appliances for large kitchens, as well as their dismantling due to possible damage to the gas supply, can only be carried out on the basis of a maintenance contract, this contract can be concluded with an authorized dealer, while technical regulations and standards and regulations must be observed regarding installation, electrical supply, gas connection and work safety. Technical instructions for installation and adjustment, for use by specialized technicians ONLY. The instructions that follow refer to a technician qualified for installation to carry out all operations in the most correct manner and according to the applicable standards. Any activity related to regulation etc. must only be performed with the device disconnected from the network. If it is necessary to keep the appliance under voltage, the utmost care must be taken. The type of appliance for extraction is declared on the nameplate, it is an A1 appliance.

## 8. THERMAL OUTPUT CHECK

Appliances must be checked to verify their thermal power input: The heat output is marked on the label or can be found in this manual. It is necessary to verify first if the appliance is made for the same type of gas to be used and therefore if the label corresponds to the gas type label to be used. To convert to another type of gas, it is necessary to check if the type of gas marked corresponds which is recommended in this manual. The pressure is measured by the pressure gauge of the necessary sensitivity. The pressure gauge is connected to the appropriate location, so it is necessary to unscrew the screw with an airtight cap and connect the pressure gauge. After the measurement, it is necessary to screw the screw back and check its tightness.

## 9. CONNECTING GAS CONNECTION HOSE

The gas must be connected by a tube with a maximum length of 1.5 meters of galvanized steel, copper or flexible steel hose in accordance with the applicable ground standards. Each device must have a closable tap at the inlet to easily stop the gas supply. After installing the device, we must check any gas leaks. Never check the leaks with an open fire. Materials that do not cause corrosion, for example, a soap water solution, must be used to check gas leakage. The devices underwent a thorough inspection of the manufacturer, the data on the type of gas, pressure and type of the device are listed on the label with characteristics. LPG bottles must be equipped with a controller that corresponds to the gas pressure on the equipment label in accordance with the applicable country's legislation.

## 10. LIQUID GAS CONNECTION

Connecting the appliance to the gas distribution system must be made by a steel or copper hose suitable for valid national requirements. This must be checked regularly and replaced as needed. Each appliance must be equipped with a closing tap and a quick slip. The quick slip must be freely accessible and within range of the device. After the installation, it is necessary to check that there is no gas leakage. To determine

leaks we use soapy water or detection sprays to determine possible leaks. Do not use corrosion-causing substances! All our appliances are carefully inspected. The type of gas, pressure and designation of the relevant category are listed on the production label. Connection to liquid gas: The pressure for liquid gas connection must be 28 or 30 mbar for propane/butane and 37 mbar for propane. It is necessary to check the label, measure the pressure and check the parameters of the installed nozzles with the required nozzle parameters according to the manufacturer's requirements. If the pressure is less than 25 mbar or greater than 37 mbar must not be connected to the appliance. Natural gas connection: The pressure when connecting to methane must be 18 or 20 mbar. It is necessary to check the label, measure the pressure and check the parameters of the installed nozzles with the required nozzle parameters according to the manufacturer's requirements. If the pressure is less than 15 mbar or higher than 22.5 mbar must not be connected to the appliance.

## 11. WATER CONNECTION

Water connection is done using G1/2 threaded hoses. The water supply must be fitted with separate closures that are freely accessible and within reach of the device. The device includes return valves. The water for filling the duplicator space must be softened - a maximum of 5 ° the French scale of water hardness. The water pressure must be in the range of 50-300 kPa.

## 12. CONNECTING THE ELECTRICAL CABLE TO THE NETWORK

Installation of the electrical supply - this supply must be separately secured. Ato with the corresponding circuit breaker of rated current depending on the power input of the installed device. Check the power consumption of the device on the production label on the back panel (or side) of the device. The connected ground wire must be longer than the other wires. Connect the device directly to the network, it is necessary to insert a switch between the device and the device with a minimum distance of 3 mm between the individual contacts, which corresponds to the applicable standards and load. The earth supply (yellow-green) must not be interrupted by this switch. Connect the device to the mains if the socket has adequate protection. In any case, the supply cable must be located so that it does not reach a temperature of 50 degrees higher than the environment at any point. Before the appliance is connected to the network, it is necessary to first make sure that:

- the supply circuit breaker and the internal distribution can withstand the current load of the appliance (see matrix label)
- the distribution board is equipped with effective grounding according to the standards of the relevant market and the conditions given by law
- the socket or switch in the supply is easily accessible from the appliance
- the electrical supply to the device must be made of oil-resistant material

**We disclaim any responsibility in the event that these standards are not respected and in the event of a violation of the above principles. Before first use, you must clean the device, see chapter "cleaning and maintenance". The appliance must be grounded using a screw with a grounding mark.**

- Do not insert the plug of the power supply into the electrical outlet. sockets and do not pull out the zel. sockets with wet hands and pulling on the power cord!
- Do not use extension cords or multiple sockets.
- **The mains connection point must have a maximum of the following impedance:  $Z_{MAX} = 0.042 + j 0.026 \Omega$  for the phase conductors and  $0.028 + j 0.017 \Omega$  for the neutral conductor.**

## 13. CHECK DEVICE SETTINGS FOR GAS TYPE

Our appliances are certified and regulated for natural gas (see type plate). Conversion or adaptation to a different type of gas must only be carried out by an authorized technician. Nozzles for different types of gas are in a bag packed with the boiler and are marked in hundredths of mm (technical data table).

## 14. TABULKA TRYSEK

Jmenovitý tepelný příkon				
G30 28..30 mbar	G31 30...37 mbar		kW	6,60
G30 37 mbar	G31 37 mbar	PL	kW	7,00
G30 50 mbar	G31 50 mbar		kW	7,00
G20 20 mbar			kW	7,00
G25 25 mbar	NL	NL	kW	6,60
G25 20 mbar			kW	7,00
G20 25 mbar			kW	7,00
G25.1 25 mbar			kW	7,00
G2.350 13 mbar			kW	7,00
G27 20 mbar			kW	6,60
Snížený tepelný příkon			kW	2,20
Spotřeba				
G30 28..30 mbar			kg/h	0,520
G31 30...37 mbar			kg/h	0,513
G30 37 mbar	PL		kg/h	0,552
G31 37 mbar	PL		kg/h	0,544
G30 50 mbar			kg/h	0,552
G31 50 mbar			kg/h	0,544
G20 20 mbar			m <sup>3</sup> /h	0,741
G25 25 mbar	NL		m <sup>3</sup> /h	0,812
G25 20 mbar			m <sup>3</sup> /h	0,862
G20 25 mbar			m <sup>3</sup> /h	0,741
G25.1 25 mbar			m <sup>3</sup> /h	0,860
G2.350 13 mbar			m <sup>3</sup> /h	1,029
G27 20 mbar			m <sup>3</sup> /h	0,852

## 15. KONTROLA NASTAVENÍ PŘÍSTROJE NA DRUH PLYNU

Naše spotřebiče jsou certifikovány a regulovány pro zemní plyn (viz. typový štítek). Přestavba nebo přizpůsobení na jiný typ plynu musí být provedena pouze oprávněným technikem. Trysky na různé typy plynu jsou v sáčku, přibaleném ke sporáku a jsou označeny v setinách mm.

Při výměně trysky hlavního hořáku je třeba postupovat následujícím způsobem:

- 1) sejměte ovládací knoflíky z předního panelu
- 2) demontujte přední panel
- 3) Dle obrázku 3 vyšroubujeme trysku z hlavního hořáku a nahradíme tryskami dle tabulky „Technická data

hořáků“

Pilotní hořák seřídíme tak, že povolíme pojistnou matici klíčem obr. 4, poté vyšroubujeme trysku pilotního hořáku s pružinkou a nahradíme tryskou pro příslušný plyn dle tabulky. Utáhneme krytku trysky klíčem.

Důležité:

Poté, co bylo provedeno seřízení spotřebiče na jiný typ plynu, je nutné změnu plynu vyznačit na štítku spotřebiče a provést následující kroky:

- Zkontrolovat případné úniky plynu
- Zkontrolovat zažehnutí a plamen hlavního hořáku
- Zkontrolovat plamen hlavního hořáku na min. výkon



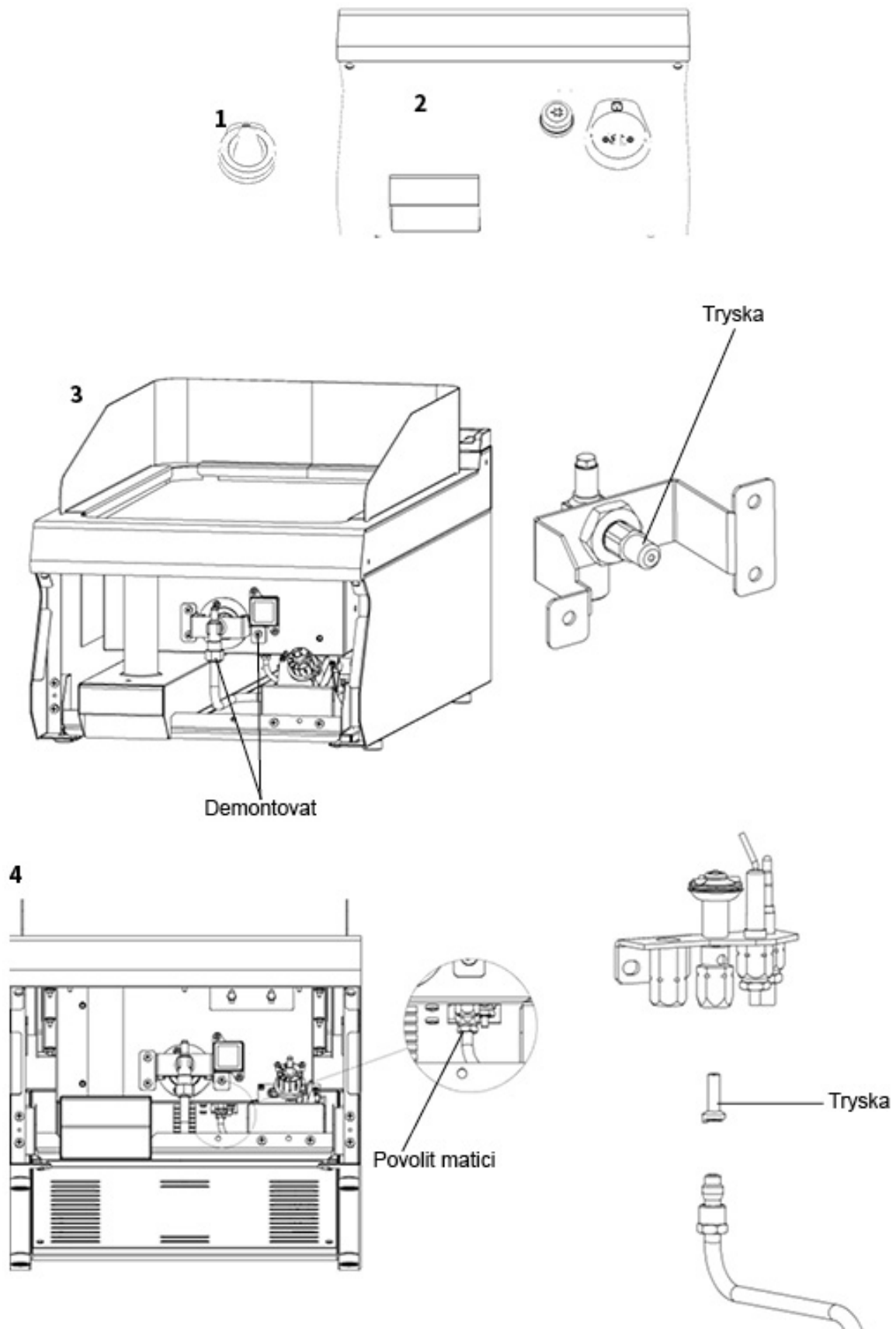

## 16. NÁVOD K POUŽITÍ

Pozor! Než-li začnete přístroj používat, je nutné z celého povrchu sejmout ochranné fólie, a pak jej dobře omýt vodou se saponátem na nádobí, a poté otřít vlhkým hadrem.

Zapálení hlavního hořáku a regulace teploty: (obr. 2)

Dejte reg.knoflík kohoutu (2) do polohy “ zapálení hlavního hořáku ” a poté jej stiskněte a držte jej, několikrát stiskněte knoflík piezo zapalovače (1) dokud se naezapálí hlavní hořák. Plamen je viditelný skrz otvor ve předním panelu (3). Po zapálení hořáku držte knoflík číslo (2) stisknutý ještě několik sekund, než se zahřeje termopojistka, poté knoflík uvolněte. Pokud plamen zhasne, celý postup opakujte.

Vypnutí celého přístroje (obr. 2)

Stačí otočit knoflíkem (2) do polohy “ 0 “.

Nádoba na sběr tuku:

Nádobu je třeba kontrolovat pravidelně a zavčas ji vyprázdnit. Nádobu musíte vyčistit po každém vypnutí spotřebiče.

**POZOR ! NÁDOBA NA SBĚR TUKU MŮŽE BÝT PŘI PROVOZU HORKÁ. NÁDOBU VYPRAZDŇUJTE, JE-LI ZAŘÍZENÍ VYCHLADLÉ.**

Přístroje, které mají varnou plochu rozdělenou na dvě poloviny je možné regulovat samostatně každou polovinu zvlášť nebo můžete použít jenom jednu polovinu. Používejte přístroj pouze pod dohledem.



obr. 2

## 17. CLEANING AND MAINTENANCE

It is recommended to have the device checked with a specialist service at least once a year. All the interventions in the device can only be carried out by a qualified person who has the authorization to do so.

**CAUTION!** The device must not be cleaned with direct or pressure water. Clean the equipment daily. Daily maintenance extends the life and efficiency of the equipment. Always turn off the main inlet to the device. Wash the stainless steel parts with a damp cloth with a detergent without coarse particles and wipe dry. Do not use abrasive or corrosive cleaning agents. Attention! Before using the device, it is necessary to remove the protective foil from the entire surface, and then wash it well with water with detergent, and then wipe it with a damp cloth. **ALERT!** The warranty does not apply to all consumables subject to normal wear (rubber seals, bulbs, glass and plastic parts, etc.). The warranty also does not apply to the device if the installation is not carried out in accordance with the instructions - an authorized worker according to the corresponding standards and if the equipment was unprofessionally manipulated (interventions in the internal equipment, etc.) or were operated by unhappy staff and contrary to the instructions for use, further The warranty does not apply to damage by natural effects or other external intervention. **Required service organization 2 times a year. After the lifetime, the shipping packaging and equipment are submitted to the collection, according to the regulations on waste management and hazardous waste.**